

MILBANK

Earls Colne Business Park, Earls Colne,
Colchester, Essex, CO6 2NS

Tel: 01787 223931

Email: design@milbank.co.uk
Email: estimating@milbank.co.uk

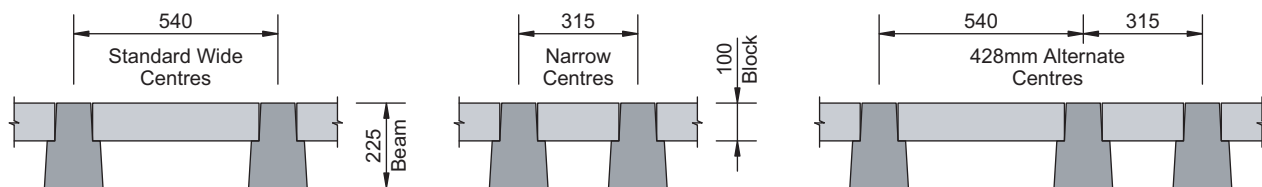

A-A

B-B

C-C

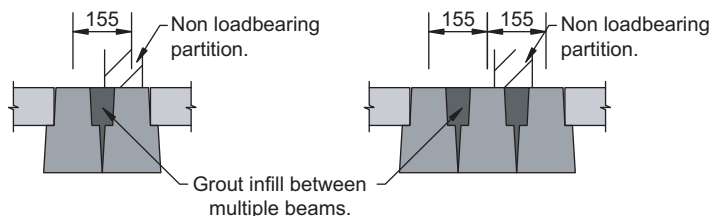

D-D

E-E

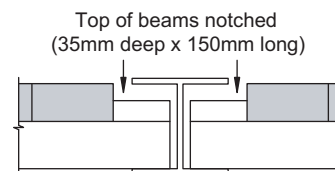

P-P

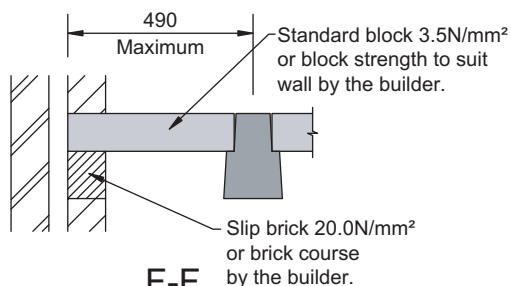

F-F

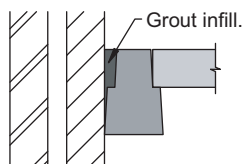

G-G

Slip brick 20.0N/mm² or infill at bearings to suit wall strength by the builder.

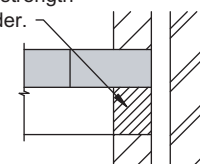

H-H

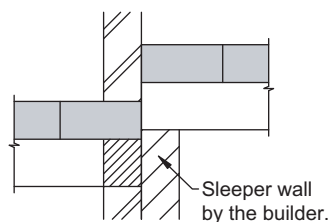

J-J

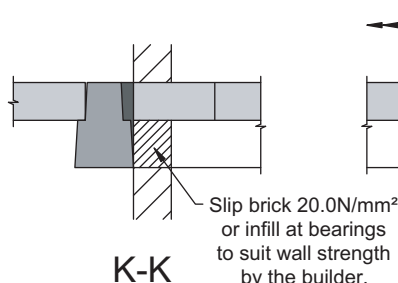

K-K

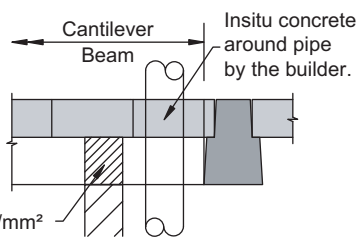

L-L

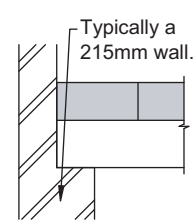

T-T

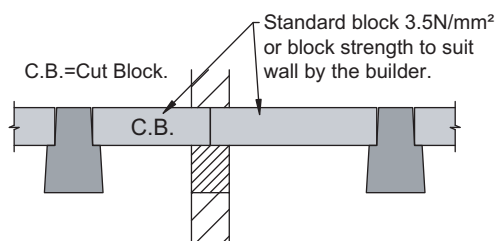

W-W

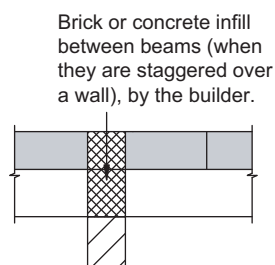

Y-Y

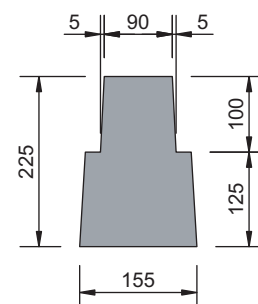



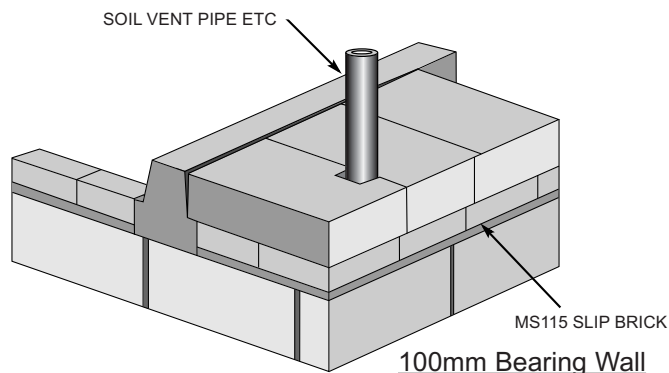

Typical 'D' Beam
Weight 67 kg/m Run

Slip Brick Detail

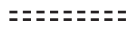

NOTES

1. Key to drawing

-  Wall down to foundation
-  Centre line of beams
-  Partition line loads (see design loads)
-  Opening in floors

2. Design

The floor beams are designed to comply with B.S.8110: Part 1. Refer to data sheet PD.

3. Infill Blocks

The density of the infill blocks used should not exceed the value shown on the Milbank drawings. Infill blocks must be capable of supporting a line load of 3.5kN on a span of 420mm. Standard block dimensions 440mm x 215mm x 100mm. Special format blocks/infill may be used in accordance with the block manufacturers recommendations.

4. Camber

All beams are prestressed and have an upward camber. The degree of the camber is dependent on the span; levelling screeds may be required prior to laying floating finishes.

5. Loading

The loadings for which the floors are designed are shown on the Milbank drawings. The Main Contractor (MC) shall ensure that these design loads are not exceeded during construction.

6. Dimensions

The beams are manufactured to the lengths shown on the drawings. The MC shall check and approve all the setting out dimensions shown on the drawings and return a copy of the drawing "signed as approved", before manufacture can commence.

7. Installation

Access and hard standing shall be provided by the MC for a mobile crane and transport as stated in the Milbank quotation. The MC shall re-route and/or remove and reinstate any overhead obstructions that may hinder the installation of the flooring units. All bearing surfaces must be constructed to the correct levels, be true and mature at the time of installing the floor units.

Ceiling Fixings

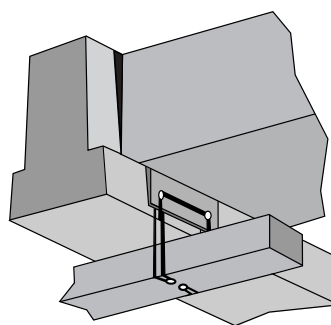

The Ceiling clip is specifically designed to be fixed after beam & block flooring systems have been laid. The Clip is economical and its "knock in" design gives "fix after" flexibility. It allows adjustment for batten size and position and avoids dust, noise and cost of drilling.

8. Protection

The beam and block floors as laid can, with due care, safely cater for normal foot traffic. The MC shall provide protection under barrow runs and at work positions for following trades.

9. Working at Heights

When working at heights (i.e. upper floors and/or floors over basements), fall protection must be provided during the installation of Beam & Block floors.

10. Ground floors

The builder shall supply and bed all D.P.C's under the floor bearings, before the flooring units are fixed. The under floor voids should be ventilated to comply with the building regulations and the N.H.B.C. requirements. All vegetable soil must be removed from under the floor and the top surface of the oversite treated with weed killer.

11. Garage floors

Garage floors are designed for an imposed load of 2.5kN/m² or a point load of 9.0kN. A minimum finish of 50mm thick screed 1:4 cement sharp sand, reinforced with A98 fabric, is required.

12. Stacking

The beams must be stacked the right way up, with timber bearers, (provided by the client) placed just in from the ends, vertically above one another. Similar length units should be stacked together.

